



Programmable Controller
MELSEC-F

FX3UC-32MT-LT-2
PROGRAMMABLE CONTROLLERS

HARDWARE MANUAL



Manual Number	JY997D31601
Revision	H
Date	May 2018

This manual describes the part names, dimensions, mounting, cabling and specifications for the product. This manual is extracted from FX3UC Series User's Manual - Hardware Edition. Refer to FX3UC Series User's Manual - Hardware Edition details. Before use, read this manual and manuals of relevant products fully to acquire proficiency in the handling and operating the product. Make sure to learn all the product information, safety information, and precautions. Store this manual in a safe place so that it can be taken out and read whenever necessary. Always forward it to the end user.

Registration
The company name and the product name to be described in this manual are the registered trademarks or trademarks of each company.

Effective May 2018
Specifications are subject to change without notice.
© 2008 Mitsubishi Electric Corporation

Safety Precautions (Read these precautions before use.)

This manual classifies the safety precautions into two categories:

and .

	Indicates that incorrect handling may cause hazardous conditions, resulting in death or severe injury.
	Indicates that incorrect handling may cause hazardous conditions, resulting in medium or slight personal injury or physical damage.

Depending on the circumstances, procedures indicated by may also cause severe injury.
It is important to follow all precautions for personal safety.

STARTUP AND MAINTENANCE PRECAUTIONS	
<ul style="list-style-type: none"> Do not touch any terminal while the PLC's power is on. Doing so may cause electric shock or malfunctions. Before cleaning or retightening terminals, cut off all phases of the power supply externally. Failure to do so may cause electric shock. 	

STARTUP AND MAINTENANCE PRECAUTIONS	
<ul style="list-style-type: none"> Before modifying or disrupting the program in operation or running the PLC, carefully read through this manual and the associated manuals and ensure the safety of the operation. An operation error may damage the machinery or cause accidents. Use the battery for memory backup correctly in FX3UC Series User's Manual - Hardware Edition. <ul style="list-style-type: none"> Use the battery only for the specified purpose. Connect the battery correctly. Do not charge, disassemble, heat, put in fire, short-circuit, connect reversely, weld, swallow or burn the battery, or apply excessive forces (vibration, impact, drop, etc.) to the battery. Do not store or use the battery at high temperatures or expose to direct sunlight. Do not expose to water, bring near fire or touch liquid leakage or other contents directly. Incorrect handling of the battery may cause heat excessive generation, bursting, ignition, liquid leakage or deformation, and lead to injury, fire or failures and malfunctions of facilities and other equipment. 	

STARTUP AND MAINTENANCE PRECAUTIONS	
<ul style="list-style-type: none"> Turn off the power to the PLC before attaching or detaching the memory cassette. If the memory cassette is attached or detached while the PLC's power is on, the data in the memory may be destroyed, or the memory cassette may be damaged. Do not disassemble or modify the PLC. Doing so may cause fire, equipment failures, or malfunctions. For repair, contact your local Mitsubishi Electric representative. Turn off the power to the PLC before connecting or disconnecting any extension cable. Failure to do so may cause equipment failures or malfunctions. Turn off the power to the PLC before attaching or detaching the following devices. Failure to do so may cause equipment failures or malfunctions. <ul style="list-style-type: none"> Peripheral devices, display module, expansion boards. Extension units/blocks, connector conversion adapter, extension power supply units, special adapters, and FX Series terminal blocks. Battery and memory cassettes 	

DISPOSAL PRECAUTIONS	
<ul style="list-style-type: none"> Please contact a certified electronic waste disposal company for the environmentally safe recycling and disposal of your device. When disposing of batteries, separate them from other waste according to local regulations. (For details of the Battery Directive in EU countries, refer to FX3UC Series User's Manual - Hardware Edition.) 	

TRANSPORTATION AND STORAGE PRECAUTIONS	
<ul style="list-style-type: none"> Before transporting the PLC, turn on the power to the PLC to check that the BAT LED is off, and check the battery life. If the PLC is transported with the BAT LED on or the battery exhausted, the battery-backed data may be unstable during transportation. The PLC is a precision instrument. During transportation, avoid impacts larger than those specified in Section 2.1 by using dedicated packaging boxes and shock-absorbing pallets. Failure to do so may cause failures in the PLC. After transportation, verify operation of the PLC and check for damage of the mounting part, etc. When transporting lithium batteries, follow required transportation regulations. (For details of the regulated products, refer to FX3UC Series User's Manual - Hardware Edition.) 	

Certification of UL, cUL standards

The FX3U(C) series and FX2NC/FX2N series input/output extension blocks supporting UL, cUL standards are as follows:
(For other products that correspond with the UL, cUL standards please refer to the FX3UC Series User's Manual - Hardware Edition or catalog.)

UL, cUL file number :E95239
Models : MELSEC FX3U(C) series manufactured

- FX3UC-32MT-LT-2
- FX3U-232ADP(-MB)
- FX3U-CF-ADP
- FX3U-4AD-ADP
- FX3U-3A-ADP
- FX3U-4AD-PTW-ADP
- FX3U-4AD-TC-ADP
- FX3UC-1PS-5V
- FX3U-485ADP(-MB)
- FX3U-ENET-ADP
- FX3U-4DA-ADP
- FX3U-4AD-PT-ADP
- FX3U-4AD-PNK-ADP

Models : MELSEC FX2NC series manufactured

- FX2NC-16EX
- FX2NC-16EYT
- FX2NC-16EX-T
- FX2NC-32EX
- FX2NC-32EYT
- FX2NC-16EYR-T

Models : MELSEC FX2N series manufactured

- FX2N-8EYR-S-ES/UL
- FX2N-8EX-UA1/UL
- FX2N-16EYS

Compliance with EC directive (CE Marking)

This document does not guarantee that a mechanical system including this product will comply with the following standards. Compliance to EMC directive and LVD directive of the entire mechanical system should be checked by the user / manufacturer. For more details please contact the local Mitsubishi Electric sales site. (For other products that correspond with the EC directive please refer to the FX3UC Series User's Manual - Hardware Edition or catalog.)

Requirement for Compliance with EMC directive

The following products have shown compliance through direct testing (of the identified standards below) and design analysis (through the creation of a technical construction file) to the European Directive for Electromagnetic Compatibility (2014/30/EU) when used as directed by the appropriate documentation.

Attention

This product is designed for use in industrial applications.

Type : Programmable Controller (Open Type Equipment)
Models : MELSEC FX3U(C) series and FX2NC series manufactured

from May 1st, 2005	FX3U-FLROM-16	FX3U-FLROM-64L
from June 1st, 2005	FX3U-232ADP	FX3U-485ADP
	FX3U-4AD-ADP	FX3U-4DA-ADP
	FX3U-4AD-PT-ADP	FX3U-4AD-TC-ADP
	FX3U-232-BD	FX3U-422-BD
	FX3U-485-BD	FX3U-CNV-BD
	FX3U-USB-BD	
	FX3U-FLROM-64	

from April 1st, 2007	FX3U-232ADP-MB	FX3U-485ADP-MB
from October 1st, 2007	FX3UC-1PS-5V	
	FX2NC-★ ★ EX	FX2NC-★ ★ EYT
	Where ★ ★ indicates:16,32	
	FX2NC-16EX-T	

from December 1st, 2007	FX3U-4AD-PTW-ADP	
	FX3U-4AD-PNK-ADP	

from April 1st, 2008	FX3UC-32MT-LT-2*	
from June 1st, 2009	FX3U-3A-ADP	FX3U-CF-ADP
from September 1st, 2010	FX3U-8AV-BD	
from May 1st, 2011	FX3U-FLROM-1M	
from February 1st, 2012	FX3U-ENET-ADP	

* For the FX3UC-32MT-LT-2, those manufactured before July 31st, 2010 are compliant with EN61131-2:2003, those after August 1st, 2010 are compliant with EN61131-2:2007

Standard	Remark
EN61131-2:2007 Programmable controllers - Equipment requirements and tests	Compliance with all relevant aspects of the standard. EMI <ul style="list-style-type: none"> Radiated Emission Conducted Emission EMS <ul style="list-style-type: none"> Radiated electromagnetic field Fast transient burst Electrostatic discharge High-energy surge Voltage drops and interruptions Conducted RF Power frequency magnetic field

Models : MELSEC FX2NC series manufactured	
from October 1st, 2007	FX2NC-★ ★ EX
	FX2NC-★ ★ EYT
	Where ★ ★ indicates:16,32
	FX2NC-16EX-T
	FX2NC-16EYR-T

Standard	Remark
EN61000-6-4:2007 - Generic emission standard Industrial environment	Compliance with all relevant aspects of the standard. <ul style="list-style-type: none"> Emission-Enclosure port Emission-Low voltage AC mains port
EN50081-2:1993 Electromagnetic compatibility	Emission-Telecommunications/network port
EN61000-6-2:2005 - Generic immunity standard Industrial environment	Compliance with all relevant aspects of the standard. <ul style="list-style-type: none"> Radio-frequency electromagnetic field. Amplitude modulated Fast transients Electrostatic discharge Surges Voltage dips Voltage interruptions Radio-frequency common mode Power-frequency magnetic field

Models : MELSEC FX2N series manufactured

from September 1st, 2010 FX2N-8EYR-S-ES/UL

Standard	Remark
EN61131-2:2007 Programmable controllers - Equipment requirements and tests	Compliance with all relevant aspects of the standard. EMI <ul style="list-style-type: none"> • Radiated Emission • Conducted Emission EMS <ul style="list-style-type: none"> • Radiated electromagnetic field • Fast transient burst • Electrostatic discharge • High-energy surge • Voltage drops and interruptions • Conducted RF • Power frequency magnetic field

Requirement for Compliance with LVD directive

The following products have shown compliance through direct testing (of the identified standards below) and design analysis (through the creation of a technical construction file) to the European Directive for Low Voltage (2014/35/EU) when used as directed by the appropriate documentation.

Type : Programmable Controller (Open Type Equipment)**Models : MELSEC FX2NC series manufactured**

from October 1st, 2007 FX2NC-16EYR-T

Standard	Remark
IEC1010-1:1990 /A1:1992 BSEN61010-1:1993 * Safety requirements for electrical equipment for measurement, control, and laboratory use - General requirements	The equipment has been assessed as a component for fitting in a suitable enclosure which meets the requirements of IEC 1010-1:1990+A1:1992

* Compliance to BSEN61010-1 is claimed through virtue of direct compliance to IEC1010-1 and Amendment 1.

Models : MELSEC FX2N series manufactured

from September 1st, 2010 FX2N-8EYR-S-ES/UL

Standard	Remark
EN61131-2:2007 Programmable controllers - Equipment requirements and tests	The equipment has been assessed as a component for fitting in a suitable enclosure which meets the requirements of EN61131-2:2007

Caution for compliance with EC Directive**Installation in Enclosure**

Programmable logic controllers are open-type devices that must be installed and used within conductive control boxes. Please use the FX3UC-32MT-LT-2 programmable logic controllers while installed in conductive shielded control boxes. Please secure the control box lid to the control box (for conduction). Installation within a control box greatly affects the safety of the system and aids in shielding noise from the programmable logic controller.

Caution for Analog Products in use

The analog special adapters have been found to be compliant to the European standards in the aforesaid manual and directive. However, for the very best performance from what are in fact delicate measuring and controlled output device Mitsubishi Electric would like to make the following points;

As analog devices are sensitive by nature, their use should be considered carefully. For users of proprietary cables (integral with sensors or actuators), these users should follow the manufacturers' installation requirements.

Mitsubishi Electric recommends that shielded cables be used. If no other EMC protection is provided, then users may experience temporary loss of accuracy between +10%/-10% in very heavy industrial areas.

However, Mitsubishi Electric suggests that when adequate EMC precautions are followed with general good EMC practice for the users complete control system.

- Sensitive analog cables should not be laid next to or bound with high voltage cabling. Where possible, users should run analog cables separately.
- Good cable shielding should be used. When grounding the shield - ensure that no loops are accidentally created.
- When reading analog values, EMC induced errors can be smoothed out by averaging the readings. This can be achieved either through functions on the analog special adapter/block or through the user's program in the FX3UC-32MT-LT-2 main unit.

Caution for CC-Link/LT Products in use

- Use the CC-Link/LT module in Zone A^{*1} as defined in EN61131-2. The terminal and the wiring for the following table can be used in zone B^{*1}.

Classification	Model	Terminal that can be used in zone B	Rated load voltage
Relay output ^{*2}	CL1Y4-R1B1 CL1Y4-R1B2	Terminal to connect output signals and load power supply.	240V AC or less ^{*3} 30V DC or less
DC input/ Relay output ^{*2}	CL1XY4-DR1B2 CL1XY8-DR1B2	Terminal to connect output signals and load power supply.	240V AC or less ^{*3} 30V DC or less
CC-Link/LT Dedicated Power Supply	CL1PSU-2A	Terminal block to connect power supply.	100/120/200/ 230/240V AC

^{*1} Zone defined in EN61131-2

Separation defined in EN61131-2 for EMC LVD regulation decided depending on condition in industrial setting.

Zone C = Factory mains which is isolated from public mains by dedicated transformers.

Zone B = Dedicated power distribution which is protected by secondary surge protection.(300V or less in the rated voltage is assumed.)

Zone A = Local power distribution which is isolated from dedicated power distribution by AC/DC converters, isolation transformers, etc.(120V or less in the rated voltage is assumed.)

^{*2} Terminal block connection type.

^{*3} 250V AC or less when the unit dose not comply with UL or cUL standards.

- When the following models use the CC-Link/LT power adapter model (CL1PAD1), a power line connecting to the external power supply terminal of the CL1PAD1 must be 30 m (98' 5") or less.

Classification	Model
Analog-Digital Converter ^{*4}	CL2AD4-B
Digital-Analog Converter ^{*4}	CL2DA2-B

^{*4} Terminal block connection type.

Associated manuals

FX3UC-32MT-LT-2 PLC (main unit) comes with this document (hardware manual).

For a detailed explanation of the FX3UC Series hardware and information on PLC programming instructions and special extension unit/block, refer to the relevant documents.

Manual name	Manual No.	Description
FX3UC Series User's Manual - Hardware Edition	JY997D28701 MODEL CODE: 09R519	Explains the FX3UC Series PLC specifications for I/O, wiring, installation, and maintenance.
FX3S/FX3G/FX3GC/ FX3U/FX3UC Series Programming Manual - Basic & Applied Instruction Edition	JY997D16601 MODEL CODE: 09R517	Describes PLC programming for basic/ applied instructions STL/ SFC programming and system devices.
MELSEC-Q/L/F Structured Programming Manual (Fundamentals)	SH-080782 MODEL CODE: 13JW06	Programming methods, specifications, functions, etc. required to create structured programs.
FXCPU Structured Programming Manual [Device & Common]	JY997D26001 MODEL CODE: 09R925	Devices, parameters, etc. provided in structured projects of GX Works2.
FXCPU Structured Programming Manual [Basic & Applied Instruction]	JY997D34701 MODEL CODE: 09R926	Sequence instructions provided in structured projects of GX Works2.
FXCPU Structured Programming Manual [Application Functions]	JY997D34801 MODEL CODE: 09R927	Application functions provided in structured projects of GX Works2.
FX Series User's Manual - Data Communication Edition	JY997D16901 MODEL CODE: 09R715	Explains N:N Network, parallel link, computer link, non-protocol communication by RS instructions/FX2N-232IF.
FX3S/FX3G/FX3GC/ FX3U/FX3UC Series User's Manual - Analog Control Edition	JY997D16701 MODEL CODE: 09R619	Describes specifications for analog control and programming methods for the FX3S/FX3G/FX3GC/ FX3U/FX3UC Series PLC.
FX3S/FX3G/FX3GC/ FX3U/FX3UC Series User's Manual - Positioning Control Edition	JY997D16801 MODEL CODE: 09R620	Explains the positioning control specifications of the FX3S/FX3G/FX3GC/ FX3U/FX3UC Series and programming procedures

How to obtain manuals

For product manuals or documents, consult with the Mitsubishi Electric dealer from who you purchased your product.

Incorporated Items

Verify that the following product and items are included in the package.

	Included Items	
Main units	Product	1 unit
	FX2NC-100MPCB [1m (3' 3"), three wire]	1 cable
	FX2NC-100BPCB [1m (3' 3"), two wire]	1 cable
	Manuals [Japanese version, English version]	1 manual each
Input / output extension blocks		
FX2NC-□□EX FX2NC-16EX-T	Product	1 unit
	FX2NC-10BPCB1 [0.1m (3.93"), double-ended]	1 cable
FX2NC-□□EYT FX2NC-16EYR-T	Product	1 unit

1. Outline

1.1 Part names

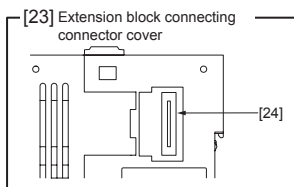
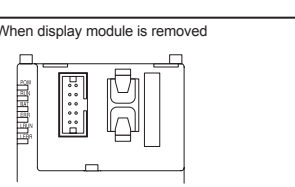
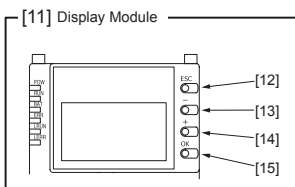
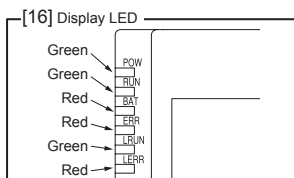
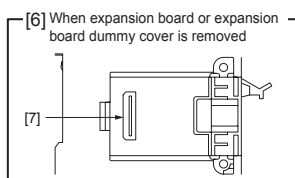
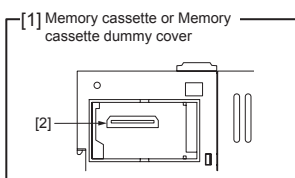
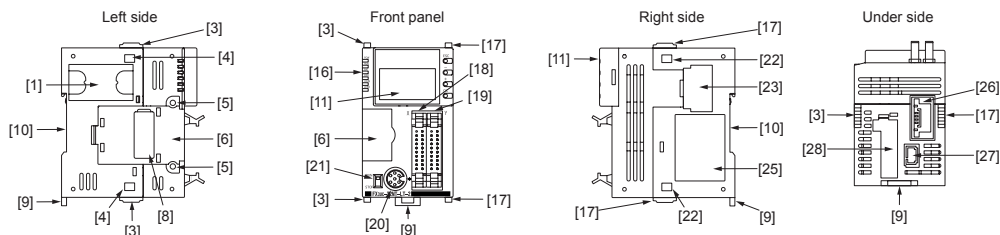

No.	Name
[1]	Memory cassette dummy cover
[2]	Memory cassette connecting connector
[3]	Special adapter connecting hooks
[4]	Special adapter connecting holes
[5]	Expansion board fixing holes
[6]	Expansion board dummy cover
[7]	Expansion board connecting connector
[8]	Special adapter connector cover Connectors are not provided when expansion board is not used.
[9]	DIN rail mounting hooks
[10]	DIN rail mounting groove [DIN rail: DIN46277(35mm(1.38")wide)]
[11]	Display Module
[12]	"ESC" button
[13]	"-" button
[14]	"+" button
[15]	"OK" button

No.	Name	
[16]	POW LED	On while power to the PLC is on.
	RUN LED	On while the PLC is running.
	BAT LED	Lights when the battery voltage drops.
	ERR LED	Flashing when a program error occurs. Lights when a CPU error occurs.
	L RUN LED	On while data link being executed (CC-link/LT built-in master).
	L ERR LED	On while data link being error (CC-link/LT built-in master).
[17]	FX3UC, FX2NC Extension block connecting hooks	
[18]	Input connector	
[19]	Output connector	
[20]	Peripheral device connector (RS-422)	
[21]	RUN/STOP switch	
[22]	FX3UC, FX2NC Extension block connecting holes	
[23]	FX3UC, FX2NC Extension block connector cover	
[24]	FX3UC, FX2NC Extension block connector	
[25]	Nameplate	
[26]	CC-Link/LT interface connector	
[27]	Power connector for main unit	
[28]	Battery cover, FX3U-32BL type battery (supplied)	

1.2 External dimensions/weight

Main unit

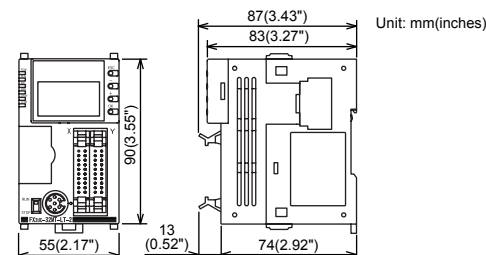

FX2NC input/output extension blocks (Connector type)

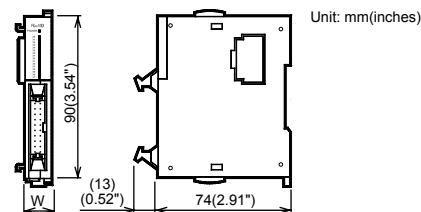

FX2NC input/output extension blocks (Terminal block type)

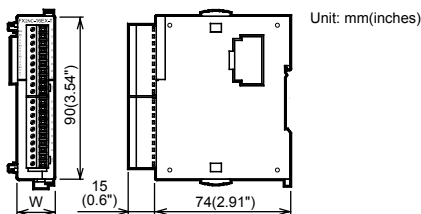

Type	Model name	W:mm (inches)	MASS (Weight): kg (lbs)
Main unit	FX3UC-32MT-LT-2	55.0 (2.17)	Approx. 0.25 (0.55)
	FX2NC-16EX	14.6 (0.57)	Approx. 0.15 (0.33)
	FX2NC-32EX	26.2 (1.03)	Approx. 0.20 (0.44)
	FX2NC-16EYT	14.6 (0.57)	Approx. 0.15 (0.33)
Input/output extension blocks (Connector type)	FX2NC-32EYT	26.2 (1.03)	Approx. 0.20 (0.44)
	FX2NC-16EX-T	20.2 (0.57)	Approx. 0.15 (0.33)
Input/output extension blocks (Terminal block type)	FX2NC-16EYR-T	24.2 (0.95)	Approx. 0.20 (0.44)

1.3 Difference with FX3uc-32MT-LT

The FX3UC-32MT-LT-2 differs from the FX3UC-32MT-LT regarding the following point.

- The FX3UC-32MT-LT-2 has no Dip switches for setting the built-in CC-Link/LT master function CC-Link/LT is set up with GX Works2, GX Developer (Ver.8.68W or later) or a display module.

2. General specifications and Installation

As for installation of the input/output extension blocks, special adapters and expansion boards, refer to FX3UC Series User's Manual - Hardware Edition.

INSTALLATION PRECAUTIONS



- Make sure to cut off all phases of the power supply externally before attempting installation or wiring work. Failure to do so may cause electric shock or damage to the product.

INSTALLATION PRECAUTIONS



- Use the product within the generic environment specifications described in section 2.1 of this manual. Never use the product in areas with excessive dust, oily smoke, conductive dusts, corrosive gas (salt air, Cl₂, H₂S, SO₂ or NO₂), flammable gas, vibration or impacts, or expose it to high temperature, condensation, or rain and wind. If the product is used in such conditions, electric shock, fire, malfunctions, deterioration or damage may occur.
- Do not touch the conductive parts of the product directly. Doing so may cause device failures or malfunctions.
- Install the product securely using a DIN rail.
- Install the product on a flat surface. If the mounting surface is rough, undue force will be applied to the PC board, thereby causing nonconformities.
- When drilling screw holes or wiring, make sure that cutting and wiring debris do not enter the ventilation slits. Failure to do so may cause fire, equipment failures or malfunctions.
- Be sure to remove the dust proof sheet from the PLC's ventilation port when installation work is completed. Failure to do so may cause fire, equipment failures or malfunctions.
- Connect the extension cables, peripheral device cables, input/output cables and battery connecting cable securely to their designated connectors. Loose connections may cause malfunctions.
- Turn off the power before attaching or detaching the following devices. Failure to do so may cause device failures or malfunctions.
 - Peripheral devices, display module, expansion boards.
 - Extension units/blocks, connector conversion adapter, extension power supply units, special adapters, and FX Series terminal blocks.
 - Battery and memory cassettes

Notes

- When a dust proof sheet is supplied with an extension unit/block, keep the sheet applied to the ventilation slits during installation and wiring work.
- To prevent temperature rise, do not install the PLC on a floor, a ceiling or a vertical surface.
- Keep a space of 50mm (1.97") or more between the unit main body and another device or structure (section 2.2 part A). Install the unit as far away as possible from high-voltage lines, high-voltage devices and power equipment.

2.1 Generic specifications [Main unit]

Item	Specification				
Ambient temperature	0 to 55°C (32 to 131°F) when operating and -25 to 75°C (-13 to 167°F) when stored				
Ambient humidity	5 to 95%RH (no condensation) when operating				
Vibration*1 resistance		Fre- quency (Hz)	Acceler- ation (m/s ²)	Half ampli- tude (mm)	Sweep Count for X, Y, Z: 10 times (80 min. in each direction)
	When installed on DIN rail	10 to 57 57 to 150	- 4.9	0.035 -	
Shock*1 resistance	147m/s ² Acceleration, Action time: 11ms, 3 times by half-sine pulse in each direction X, Y, and Z				
Noise resistance	By noise simulator at noise voltage of 1,000Vp-p, noise width of 1μs, rise time of 1ns and period of 30 to 100Hz				
Dielectric withstand voltage	500V AC for one minute		Between batch of all terminals and ground terminal		
Insulation resistance	5 MΩ or higher by 500 V DC insulation resistance tester				
Grounding	Class D grounding (grounding resistance: 100Ω or less) <Common grounding with a heavy electrical system is not allowed.>*2				
Working atmosphere	Free from corrosive or flammable gas and excessive conductive dusts				
Working altitude	<2000m ³				

*1 The criterion is shown in IEC61131-2.

*2 For common grounding, refer to section 3.1.3.

*3 The PLC cannot be used at a pressure higher than the atmospheric pressure to avoid damage.

2.2 Installation location

Install the PLC in an environment conforming to the generic specifications (section 2.1), installation precautions and notes. For more details, refer to FX3UC Series User's Manual - Hardware Edition.

Installation location in enclosure

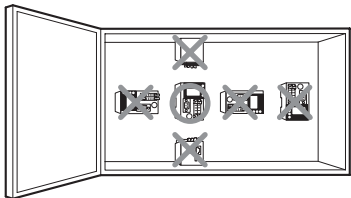

Space in enclosure

Extension devices can be connected on the left and right sides of the PLC main unit. If you intend to add extension devices in the future, keep extra space on the left and right sides open.

Configuration without extension cable

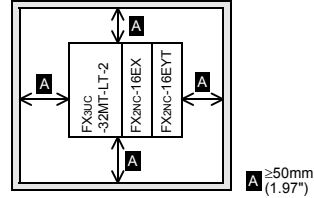

Configuration with extension cable

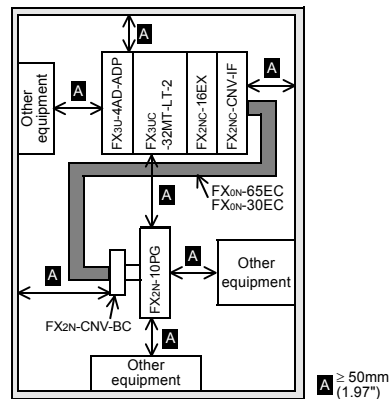

2.3 Procedures for installing to and detaching from DIN rail

The main unit can be installed on a DIN46277 rail [35mm (1.38") wide]. (It cannot be installed directly with screws.)

2.3.1 Installing methods

- 1) Turn the power supply OFF.
- 2) Push the DIN rail mounting hooks ① of all connected units/blocks as shown in the figure on the right ②.

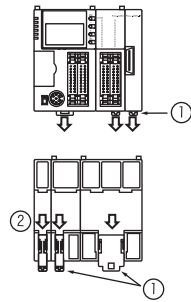

- 3) Align the upper side of the DIN rail mounting groove with the DIN rail (③ in the figure on the right).

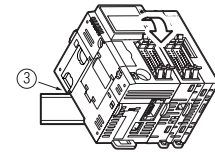

- 4) While pressing the main unit onto the DIN rail, lock the DIN rail mounting hooks as shown in the figure below ④.

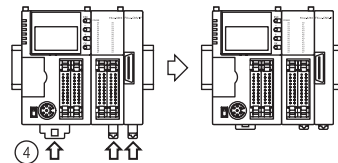

2.3.2 Removal methods

- 1) Turn the power supply OFF.
- 2) Disconnect all connected cables including the power cable, I/O cable and CC-Link/LT cable.
- 3) Insert a flathead screwdriver to the DIN rail mounting hook (① in the figure on the right).
- 4) Lever the screwdriver slightly toward direction ②, to pull out the DIN rail mounting hooks, allowing them to come off the DIN rail.
- 5) Remove the main unit from the DIN rail (③ in the figure on the right).
- 6) Push the DIN rail mounting hooks as shown in the figure on the right ④.

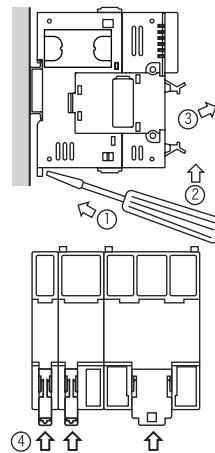

2.4 Display module Installing/Removal

The display module can be removed.

2.4.1 Removal

- 1) Turn the power supply OFF.
- 2) Gently place the tip of a flat head screwdriver to the two Display module fixing hooks to lift the display module from the main unit by about 1 mm (0.04") (right fig. ②).
- 3) Tilt the flat head screwdriver at the two Display module fixing hooks to lift the display module from the main unit by about 1 mm (0.04") (right fig. ②). Carefully perform the above trying not to bend or break the Display module fixing hooks.

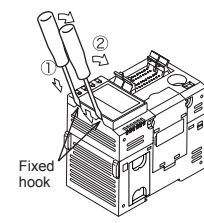

- 4) Hold the display module (right fig.) and remove the display module.

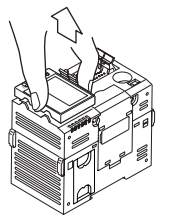

2.4.2 Installing

- 1) Turn the power supply OFF.
- 2) Put the connector of the display module on the main unit (figure on the right).
- 3) Push the display module to install it (① in the figure on the right).

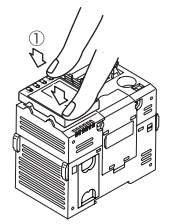

2.5 Connection of power supply connector

Use the dedicated built-in power connector to supply power to the main unit.

Power should be supplied to the main unit, FX2NC Series input extension blocks and FX2NC/FX3UC Series special function blocks. Perform crossover wiring using two (upper and lower) power connectors for extension blocks.

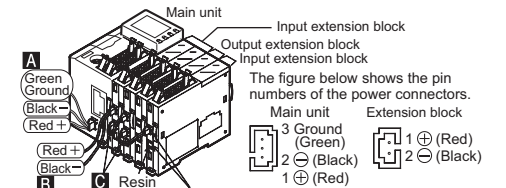

The figure below shows the pin numbers of the power connectors. Two power connectors of each extension block are connected in parallel inside the block. Accordingly, there is no discrimination between the entrance side and the exit side of the power supply. Either (upper or lower) connector can be connected. At shipment from the factory, a resin cover is attached to the lower connector. Connect the upper connector first. Remove the resin cover from the lower connector when performing crossover wiring for the later block.

Removal of the power cable

- 1) Turn the power supply OFF.
- 2) Pinch the power cable connector "a" and disconnect it in the direction of the arrow (see figure on the right).

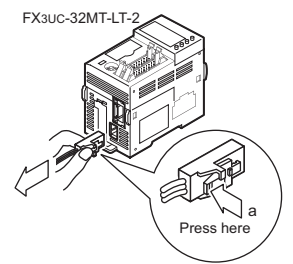

Power Cable types "A" and "B" are supplied with the main unit, while type "C" is supplied with the FX2NC-□□EX(-T) and FX2NC/FX3UC Series special function blocks.

Type	Application	Model	Length	Cable supplied with
A	Power cable for main unit	FX2NC-100MPCB	1m (3' 3")	Main unit
B	Input power cable for the FX2NC-□□EX(-T) and FX2NC/FX3UC series special function blocks.	FX2NC-100BPCB	1m (3' 3")	
C	Input power crossover cable for the FX2NC-□□EX(-T) and FX2NC/FX3UC series special function blocks.	FX2NC-10BPCB1	0.1m (3.93")	FX2NC-□□EX(-T) and FX2NC/FX3UC series special function blocks

The crossover cable (type "C") can skip up to 4 16-point output blocks to connect units. If more blocks should be skipped to supply power to an extension block, use cable type "B".

2.6 Connection to input/output connector

The input/output connectors of the Main units conform to MIL-C-83503. Refer to Chapter 4 for the I/O connector pin arrangement. (For CC-Link/LT interface connector, refer to FX3UC Series User's Manual - Hardware Edition.)

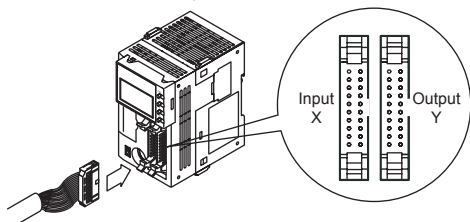

1) **Compliant connectors (commercially available connectors)**
Use a 20-pin (1-key) socket connector conforming to MIL-C-83503.

Confirm in advance that the connectors do not interfere with other parts including connector covers.

2) **Input/output cables (available from Mitsubishi)**

Input/output cables with attached connectors are available.

Model names	Length	Description	Shape
FX-16E-500CAB-S	5m (16'4")	General-purpose input/output cable	<ul style="list-style-type: none"> Single wire (Wire color: red) PLC side: A 20-pin connector
FX-16E-150CAB	1.5m (4'11")	Cables for connecting the FX Series terminal block with input/output connectors.	<ul style="list-style-type: none"> Flat cables (with tube) A 20-pin connector at both ends
FX-16E-300CAB	3m (9'10")		
FX-16E-500CAB	5m (16'4")		
FX-16E-150CAB-R	1.5m (4'11")	For terminal block connection, refer to FX3UC Series User's Manual - Hardware Edition.	<ul style="list-style-type: none"> Round multicore cables A 20-pin connector at both ends
FX-16E-300CAB-R	3m (9'10")		
FX-16E-500CAB-R	5m (16'4")		

- Stranded wire/solid wire
- Ferrule with insulation sleeve

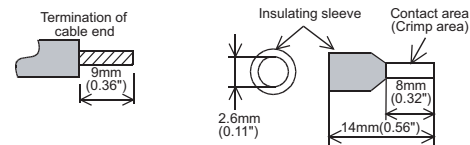

When using a ferrule with insulation sleeve, choose a wire with proper cable sheath referring to the above outside dimensions, otherwise the wire cannot be inserted easily.

2.7.2 Tightening Torque

Tighten the terminals to a torque of 0.22 to 0.25N•m.

Do not tighten terminal screws with a torque outside the above-mentioned range.

Failure to do so may cause equipment failures or malfunctions.

Tool

To tighten terminals, use a purchased small-sized screwdriver whose head is straight and is not widened as shown in the right figure.

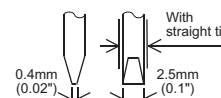

Note:

If the diameter of screwdriver grip is too small, tightening torque will not be able to be achieved. To achieve the appropriate tightening torque shown in the table above, use the following screwdriver or an appropriate replacement (grip diameter approximately 25mm (0.98")).

<Reference>

Manufacturer	Model
Phoenix Contact	SZS 0.4×2.5

3. Power supply/input/output specifications and examples of external wiring

For details of power supply and I/O wiring, or CC-Link/LT wiring, refer to the FX3UC Series User's Manual - Hardware Edition.

DESIGN PRECAUTIONS **WARNING**

- Make sure to have the following safety circuits outside of the PLC to ensure safe system operation even during external power supply problems or PLC failure. Otherwise, malfunctions may cause serious accidents.

- Most importantly, have the following: an emergency stop circuit, a protection circuit, an interlock circuit for opposite movements (such as normal vs. reverse rotation), and an interlock circuit (to prevent damage to the equipment at the upper and lower positioning limits).
- Note that when the PLC CPU detects an error, such as a watchdog timer error, during self-diagnosis, all outputs are turned off. Also, when an error that cannot be detected by the PLC CPU occurs in an input/output control block, output control may be disabled.

External circuits and mechanisms should be designed to ensure safe machinery operation in such a case.

- Note that when an error occurs in a relay, triac or transistor output device, the output could be held either on or off. For output signals that may lead to serious accidents, external circuits and mechanisms should be designed to ensure safe machinery operation in such a case.

Model names	Length	Description	Shape
FX-A32E-150CAB	1.5m (4'11")	Cables for connecting the A Series Model A6TBXY36 connector/terminal block conversion unit and input/output connector type	<ul style="list-style-type: none"> Flat cables (with tube) PLC side: Two 20-pin connectors in 16-point units. Terminal block side: A dedicated connector One common terminal covers 32 input/output terminals.
FX-A32E-300CAB	3m (9'10")		
FX-A32E-500CAB	5m (16'4")		

3) Connectors for user-made input/output cables (available from Mitsubishi)

Users should provide electric wires and a pressure bonding tool.

Model name and composition of input/output connector		Applicable electric wire (UL-1061 are recommended) and tool	
Our model name	Details of part (made by DDK Ltd.)	Electric wire size	Pressure bonding tool (made by DDK Ltd.)
FX2c-I/O-CON for flat cable	10-piece set Solderless connector FRC2-A020-30S	AWG28 (0.1mm ²) 1.27 pitch, 20-core	357J-4674D: Main body 357J-4664N: Attachment
FX2c-I/O-CON-S for bulk wire	5-piece set Housing HU-200S2-001 Solderless contact HU-411S	AWG22 (0.3mm ²)	357J-5538
FX2c-I/O-CON-SA for bulk wire	5-piece set Housing HU-200S2-001 Solderless contact HU-411SA	AWG20 (0.5mm ²)	357J-13963

4) Certified connectors (commercially available connectors)

Connectors made by DDK Ltd. shown in item 3).

2.7 Connection to input/output terminal block

2.7.1 Cable

1) Applicable cable

Type	Wire size
Single wire	0.3mm ² to 0.5mm ² (AWG22 to 20)
Double wire	0.3mm ² (AWG22)×2

2) Termination

Strip the coating of strand wire and twist the cable core before connecting it, or strip the coating of single wire before connecting it. An alternative connection is to use a ferrule with insulating sleeve.

<Reference>

Manufacturer	Model	Caulking tool
Phoenix Contact	AI 0.5-8WH	CRIMPFOX 6 ^{*1} (or CRIMPFOX 6T-F ^{*2})

*1 Old model name: CRIMPFOX ZA 3

*2 Old model name: CRIMPFOX UD 6

DESIGN PRECAUTIONS **WARNING**

- Note that when an error occurs in a remote I/O unit, the output could be held either on or off. For output signals that may lead to serious accidents, external circuits for monitoring should be provided.

DESIGN PRECAUTIONS **CAUTION**

- Do not bundle the control line and CC-Link/LT connection cables together with or lay them close to the main circuit or power line. As a guideline, lay the control line and CC-Link/LT connection cables at least 100 mm (3.94") or more away from the main circuit or power line. Noise may cause malfunctions.
- Install the product so that excessive force will not be applied to peripheral device connectors, power connectors, input/output connectors, CC-Link/LT interface connectors or CC-Link/LT connection cables. Failure to do so may result in wire damage/breakage or PLC failure.

Notes

- Simultaneously turn on and off the power supplies of the main unit and extension devices.
- Even if the power supply causes an instantaneous power failure for 5ms or less, the PLC can continue to operate.
- If a long-time power failure or an abnormal voltage drop occurs, the PLC stops, and output is turned off. When the power supply is restored, it will automatically restart (when the RUN input is on).

WIRING PRECAUTIONS **WARNING**

- Make sure to cut off all phases of the power supply externally before attempting installation or wiring work. Failure to do so may cause electric shock or damage to the product.

WIRING PRECAUTIONS **CAUTION**

- Connect the DC power supply wiring to the dedicated connectors specified in this manual. If an AC power supply is connected to a DC input/output terminal (connector) or DC power supply terminal (connector), the PLC will burn out.
- Do not wire vacant terminals externally. Doing so may damage the product.
- Perform class D grounding (grounding resistance: 100Ω or less) to the grounding terminal on the main unit. Do not use common grounding with heavy electrical systems (refer to subsection 3.1.3).
- When drilling screw holes or wiring, make sure cutting or wire debris does not enter the ventilation slits. Failure to do so may cause fire, equipment failures or malfunctions.

Notes

- Input/output wiring 50 to 100m (164'1" to 328'1") long will cause almost no problems of noise, but, generally, the wiring length should be less than 20m (65'7") to ensure the safety.
- Extension cables are easily affected by noise. Lay the cables at a distance of at least 30 to 50mm (1.19" to 1.97") away from the PLC output and other power lines.

3.1 Power supply specifications and example of external wiring

For more details, refer to FX3UC Series User's Manual - Hardware Edition.

3.1.1 Power supply specifications

The specifications for the power supply of the main unit are shown in the following table.

Item	Specification	
Supply voltage	24V DC +20% -15%*1 Ripple Voltage (p-p)5% or less	
Allowable instantaneous power failure time	Operation can be continued upon occurrence of an instantaneous power failure for 5ms or less.	
Power fuse	CPU, I/O operations power supply circuit	125V 3.15A
	CC-Link/LT built-in power supply circuit	125V 0.8A
Rush current	30A max.0.5ms/24V DC	
Power consumption*2	9W	
5V DC built-in power supply*3	5V DC, 350mA	
Built-in power supply for CC-Link/ LT networks	24V DC, 350mA	

*1 When the built-in CC-Link/LT master function is used, refer to the FX3UC Series User's Manual - Hardware Edition.

*2 Input/output extension blocks, special function units/blocks and CC-Link/LT network are not contained in power consumption. For power consumption of the FX2NC input/output extension blocks, refer to the following table. Refer to the FX3UC Series User's Manual - Hardware Edition. For the power consumed by the special function units/blocks, refer to the appropriate manuals.

Model names	Power consumption
FX2NC-16EX-T	2.2W
FX2NC-16EX	2.2W
FX2NC-32EX	4.2W
FX2NC-16EYR-T	2.2W
FX2NC-16EYT	0.35W
FX2NC-32EYT	0.7W

*3 Cannot be used to supply power to an external destination. This power is supplied to input/output extension blocks, special extension blocks, special adapters and expansion boards only.

3.1.2 Example of external wiring (power type)

Supply 24V DC power to the main unit and FX2NC-□□EX(-T) using the dedicated connector. For the details of wiring work, refer to Section 2.5. For the power supply wiring of the FX2NC input extension blocks, refer to the Subsection 3.2.3

Use a 24V DC +20% -15%*1 DC power supply whose ripple (p-p) is within 5%. The allowable range of the 24V DC power supply may be narrower when special function units/blocks are connected. For more details, refer to the FX3UC Series User's Manual - Hardware Edition

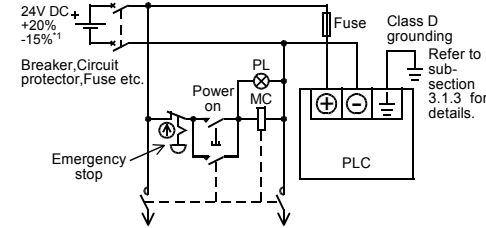

Power supply for loads connected to PLC output terminals

*1 When the built-in CC-Link/LT master function is used, refer to the FX3UC Series User's Manual - Hardware Edition.

3.1.3 Grounding

Ground the PLC as stated below.

- Perform class D grounding. (Grounding resistance: 100 Ω or less)
- Ground the PLC independently if possible. If it cannot be grounded independently, ground it jointly as shown below.

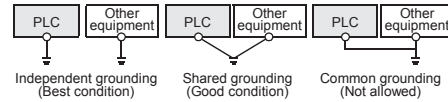

- Position the grounding point as close to the PLC as possible to decrease the length of the ground wire.

3.2 Input specifications and external wiring

For more details, refer to the FX3UC Series User's Manual - Hardware Edition

3.2.1 Input specifications

Item	Input specification (24V DC)	
Number of input points	FX3UC-32MT-LT-2: 16 points FX2NC-16EX: 16 points FX2NC-32EX: 32 points FX2NC-16EX-T: 16 points	
Input connecting type	FX3UC-32MT-LT-2: connector FX2NC-□□EX: Terminal block	
Input form	Sink	
Input signal voltage	24V DC +20% -15% Ripple Voltage (p-p)5% or less	
Input impedance	FX3UC-32MT-LT-2	X000 to X005: 3.9kΩ X006, X007: 3.3kΩ X010 to X017: 4.3kΩ

Item	Input specification (24V DC)	
Input impedance	FX2NC-□□EX(-T): 4.3Ω	
Input signal current	FX3UC-32MT-LT-2	X000 to X005: 6mA/24V DC X006, X007: 7mA/24V DC X010 to X017: 5mA/24V DC
	FX2NC-□□EX(-T)	5mA/24V DC
	ON input sensitivity current	X000 to X005: 3.5mA or more X006, X007: 4.5mA or more X010 to X017: 3.5mA or more
Input OFF current	FX3UC-32MT-LT-2: 1.5mA or less FX2NC-□□EX(-T): 3.5mA or more	
Input response time	Approx. 10ms*1	
Input signal form	No-voltage contact input NPN open collector transistor	
Circuit insulation	Photocoupler insulation	
Operation display	FX3UC-32MT-LT-2	Monitor by the display module
	FX2NC-□□EX(-T)	LED on panel turns ON when photocoupler is driven.

*1 X000 to X017 use adjustable digital filter values. For details, refer to FX3UC Series User's Manual - Hardware Edition.

3.2.2 Handling of 24V DC input

Inputs turn ON when the input terminal and COM terminal are electrically connected with a no-voltage contact or NPN open collector transistor

3.2.3 Example of input wiring

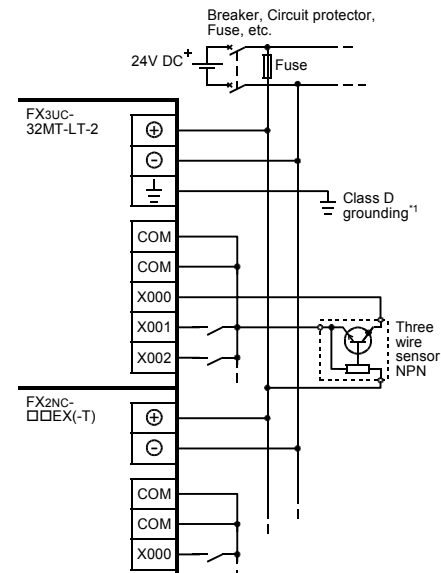

*1 The grounding resistance should be 100Ω or less.

3.3 Output specifications and example of external wiring

For more details, refer to the FX3UC Series User's Manual - Hardware Edition

3.3.1 Transistor output specifications

Item	Output specification (Transistor)			
Number of output points	FX3UC-32MT-LT-2: 16 points FX2NC-16EYT: 16 points FX2NC-32EYT: 32 points			
	Output connecting type	Connector		
	Output form	Sink		
External power supply	5 to 30V DC			
Max. load	Resistance load	FX3UC-32MT-LT-2	Y000 to Y003: 0.3A/point Y004 to Y017: 0.1A/point	Make sure that the total load current of 8 resistance load points is 0.8A*1 or less.
	Inductive load	FX3UC-32MT-LT-2	Y000 to Y003: 7.2W/point (24V DC) Y004 to Y017: 2.4W/point (24V DC)	Make sure that the total load of 16 inductive load points is 38.4W/24V DC or less.
		FX2NC-□□EYT	2.4W/point (24V DC)	
	Open circuit leakage current	0.1mA or less/30V DC		
Response time	OFF → ON	FX3UC-32MT-LT-2	Y000 to Y003: 5μs or less/10mA or more (5 to 24V DC)*2 Y004 to Y017: 0.2ms or less/100mA or more (at 24V DC)*3	
		FX2NC-□□EYT	0.2ms or less/100mA or more (at 24V DC)	
	ON → OFF	FX3UC-32MT-LT-2	Y000 to Y003: 5μs or less/10mA or more (5 to 24V DC)*2 Y004 to Y017: 0.2ms or less/100mA or more (at 24V DC)*3	
		FX2NC-□□EYT	0.2ms or less/100mA or more (at 24V DC)	
Circuit insulation	Photocoupler insulation			
Display of output operation	FX3UC-32MT-LT-2: Monitor by the display module FX2NC-□□EYT: LED on panel turns ON when photocoupler is driven.			

1 When the two COM terminals are connected outside the PLC, resistance load is 1.6A or less. Where * indicates:1 or 2

*2 When using an instruction related to pulse train output or positioning, make sure to set the load current to 10 to 100mA (5 to 24V DC).

*3 The transistor OFF time is longer under lighter loads. For example, under a load of 24V DC 40mA, the response time is approx. 0.3ms. When response performance is required under light loads, provide a dummy resistor to increase the load current. For details, refer to FX3UC Series User's Manual - Hardware Edition.

3.3.2 Handling of transistor output circuit

Output terminal:

The main unit and FX2NC input/output extension block have 16 transistor output points per common.

Two COM* terminals connected to each other inside the PLC are provided for outputs.

Connect two COM* terminals outside the PLC so that the load applied to each COM* terminal is smaller.

Where * indicates:1 or 2

Output current

The ON voltage of the output transistor is approx. 1.5V. When driving a semiconductor element, carefully check the input voltage characteristics of the applied element.

3.3.3 Example of transistor output wiring

1. Examples of sink output wiring

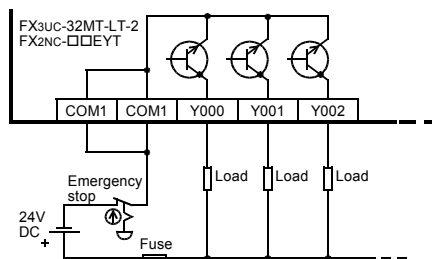

3.3.4 Relay output specifications

Item	Output specification (Relay)	
Number of output points	FX2NC-16EYR-T: 16 points	
Output connecting type	Terminal block	
External power supply	30V DC or less or 240V AC or less (250V AC or less when the unit does not comply with CE, UL or cUL standards)	
Max. load	Resistance load When using one COM□ terminal, make sure that the total load current of 8 resistance load points is 4A or less. When connecting two COM□ terminals outside the PLC, make sure that the total load current of 8 resistance load points is 8A or less.	
	Inductive load 80VA For the product life of relay contacts, refer to the FX3UC Series User's Manual - Hardware Edition.	
Open circuit leakage current	-	
Minimum load	5V DC, 2mA (reference value)	
Response time	OFF→ON	Approx. 10ms
	ON→OFF	Approx. 10ms

Item	Output specification (Relay)
Circuit insulation	Mechanical insulation
Display of output operation	LED on panel lights when power is applied to relay coil.

3.3.5 Handling of relay output circuit

Output terminal:

The FX2NC-16EYR-T has 8 relay output points per common.

Two COM* terminals connected to each other inside the PLC are provided for outputs.

Connect two COM* terminals outside the PLC so that the load applied to each COM* terminal is smaller.

Where * indicates:1 or 2

3.3.6 Example of relay output wiring

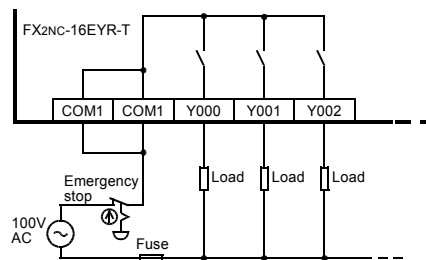

3.4 Cautions on input/output wiring

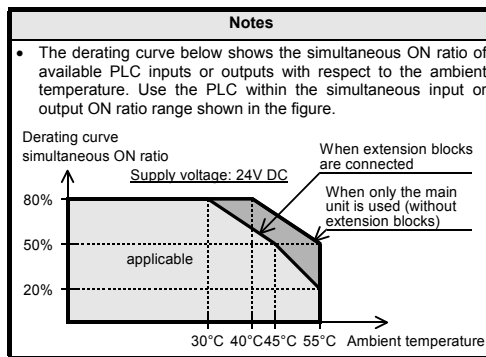

3.4.1 Instructions for input devices

The input current of this PLC is 5 to 7mA/24V DC. Use input devices applicable to this minute current. If switches for larger current are being used, contact failure may occur. For details, refer to FX3UC Series User's Manual - Hardware Edition.

- In the case of input devices with built-in series diodes: The voltage drop of the series diode should be approx. 4V or less. When lead switches with a series LED are used, up to two switches can be connected in series. Also make sure that the input current is over the input-sensing level while the switches are ON.

- In the case of input device with built-in parallel resistance: Use a device with a parallel resistance of 15kΩ or more. When the resistance is less than 15kΩ, connect a bleeder resistor.

- In the case of 2-wire proximity switch: Use a two-wire proximity switch whose leakage current is 1.5mA or less when the switch is off. When the current is larger than 1.5mA, connect a bleeder resistor.

3.4.2 Cautions on transistor output wiring

For more details, refer to FX3UC Series User's Manual - Hardware Edition.

- Protection circuit for load short-circuits
A short-circuit at a load connected to an output terminal could cause burnout at the output element or the PC board. To prevent this, a protection fuse should be included at the output. Use a load power supply capacity that is two times or more the total rated capacity of the fuses connected to the load circuit.
- Contact protection circuit for inductive loads
When an inductive load is connected, connect a diode (for commutation) in parallel with the load as necessary. The diode (for commutation) must comply with the following specifications.

Reverse voltage	5 to 10 times of the load voltage
Forward current	Load current or more

- Interlock
Loads, such as contactors for normal and reverse rotations, that must not be turned on simultaneously should have an interlock in the PLC program and an external interlock.

3.4.3 Cautions on relay output wiring

For more details, refer to FX3UC Series User's Manual - Hardware Edition.

- Protection circuit for load short-circuits
A short-circuit at a load connected to an output terminal could cause burnout at the output element or the PC board. To prevent this, a protection fuse should be included at the output.
- Protection circuit of contact when inductive load is used
An internal protection circuit for the relays is not provided for the relay output circuit in the extension block. It is recommended to use inductive loads with built-in protection circuits. When using loads without built-in protection circuits, insert an external contact protection circuit, etc. to reduce noise and extend the product life.

- DC circuit
Connect a diode in parallel with the load. Use a diode (for commutation) having the following specifications.

Reverse voltage	5 to 10 times of the load voltage
Forward current	Load current or more

- AC circuit
Connect the surge absorber (combined CR components such as a surge killer and spark killer, etc.) parallel to the load. Select the rated voltage of the surge absorber suitable to the output used. Refer to the table below for other specifications.

Electrostatic capacity	Approx. 0.1μF
Resistance value	Approx. 100 to 200Ω

- Interlock
Loads, such as contactors for normal and reverse rotations, that must not be turned on simultaneously should have an interlock in the PLC program and an external interlock.
- Common mode
Use output contacts of the PLC in the common mode.

4. Terminal Layout

4.1 Main units

4.1.1 FX3UC-32MT-LT-2

FX3UC-32MT-LT-2

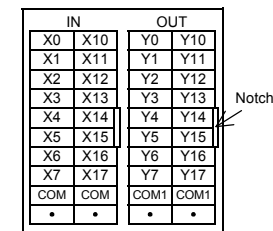

4.2 FX2nc input/output extension blocks

4.2.1 FX2NC-□□EX

FX2NC-16EX

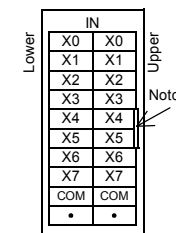

FX2NC-32EX

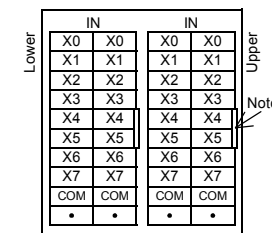

4.2.2 FX2NC-□□EYT

FX2NC-16EYT

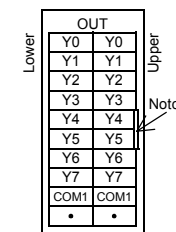

FX2NC-32EYT

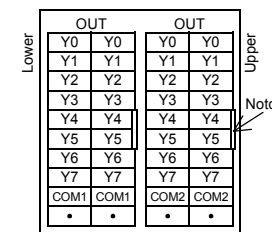

4.2.3 FX2NC-16EX-T, FX2NC-16EYR-T

FX2NC-16EX-T FX2NC-16EYR-T

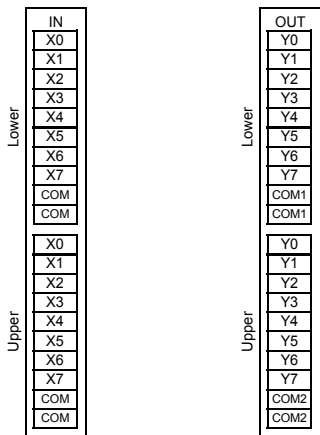

「电器电子产品有害物质限制使用标识要求」的表示方式



Note: This symbol mark is for China only.

含有有害6物质的名称, 含有量, 含有部品
 本产品中所含有的有害6物质的名称, 含有量, 含有部品如下表所示。

产品中有害物质的名称及含量

部件名称	有害物质					
	铅 (Pb)	汞 (Hg)	镉 (Cd)	六价铬 (Cr (VI))	多溴联苯 (PBB)	多溴二苯醚 (PBDE)
可编程控制器	○	○	○	○	○	○
外壳	○	○	○	○	○	○
印刷基板	×	○	○	○	○	○

本表格依据SJ/T 11364的规定编制。

- :表示该有害物质在该部件所有均质材料中的含量均在GB/T 26572规定的限量要求以下。
- ×:表示该有害物质至少在该部件的某一均质材料中的含量超出GB/T 26572规定的限量要求。

基于中国标准法的参考规格: GB/T15969.2

This manual confers no industrial property rights or any rights of any other kind, nor does it confer any patent licenses. Mitsubishi Electric Corporation cannot be held responsible for any problems involving industrial property rights which may occur as a result of using the contents noted in this manual.

Warranty

Exclusion of loss in opportunity and secondary loss from warranty liability
 Regardless of the gratis warranty term, Mitsubishi shall not be liable for compensation to:
 (1) Damages caused by any cause found not to be the responsibility of Mitsubishi.
 (2) Loss in opportunity, lost profits incurred to the user by Failures of Mitsubishi products.
 (3) Special damages and secondary damages whether foreseeable or not, compensation for accidents, and compensation for damages to products other than Mitsubishi products.
 (4) Replacement by the user, maintenance of on-site equipment, start-up test run and other tasks.

For safe use

- This product has been manufactured as a general-purpose part for general industries, and has not been designed or manufactured to be incorporated in a device or system used in purposes related to human life.
- Before using the product for special purposes such as nuclear power, electric power, aerospace, medicine or passenger movement vehicles, consult with Mitsubishi Electric.
- This product has been manufactured under strict quality control. However when installing the product where major accidents or losses could occur if the product fails, install appropriate backup or failsafe functions in the system.

MITSUBISHI ELECTRIC CORPORATION

HEAD OFFICE : TOKYO BUILDING, 2-7-3 MARUNOUCHI, CHIYODA-KU, TOKYO 100-8310, JAPAN